

VYROBENO  
DLE NORMY

OZNAČENÍ LOGO  
A TYP

ATEST  
NA PITNOU VODU



## Mosazné fitinky

KATALOGOVÉ ČÍSLO VIZ TABULKA

### Použití

- Tvarovky/fitinky se používají k transportu vody včetně vody pro lidskou spotřebu a plynu
- Pracovní tlak 1,0 Mpa a teplota od 0 ° do 110 °C

### Vlastnosti

- Vyrobeno dle normy EN 1254-4 (EN 1254-1)
- Velikosti připojení od 1/2" do 2"
- Typy spoje – jsou určeny pro spojování součástí se závitem dle EN 10226-1 (ISO 7-1)
- Vnější závity mají kuželovitost 1:16, vnitřní závity jsou válcové
- Vyráběny jsou tvářením a následným třískovým obráběním
- Každá fitinka je opatřena logem společnosti HECKL, rozměrem a typem materiálu
- Značení je prováděno laserem – gravírováno
- Vnější závity jsou zdrsněné pro lepší přilnavost těsnícího materiálu

### Materiál

- Materiál mosaz CW617N (značení I.) nebo CW602N (značení II.), bez povrchové úpravy
- Tvarovky jsou certifikovány na pitnou vodu

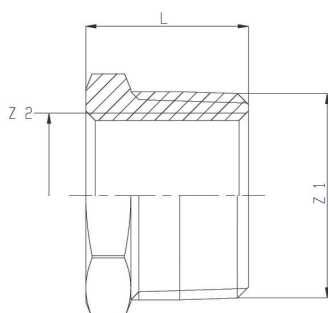

### Redukce

rozměr Z1 x Z2	L (mm)	hmotnost (g)	balení (ks)		katalogové číslo	
			sáček	krabice	CW617N	CW602N
3/4" x 1/2"	22	40	20	400	C513510020015	C513710020015
1" x 1/2"	26	99	10	170	C513510025015	C513710025015
1" x 3/4"	26	72	10	220	C513510025020	C513710025020
5/4" x 1/2"	30	192	5	80	C513510032015	C513710032015
5/4" x 3/4"	30	174	5	80	C513510032020	C513710032020
5/4" x 1"	30	137	5	80	C513510032025	C513710032025
6/4" x 1/2"	30	264	5	60	C513510040015	C513710040015
6/4" x 3/4"	30	242	5	60	C513510040020	C513710040020
6/4" x 1"	30	210	5	60	C513510040025	C513710040025
6/4" x 5/4"	30	120	5	60	C513510040032	C513710040032
2" x 3/4"	35	440	2	36	C513510050020	C513710050020
2" x 1"	35	407	2	36	C513510050025	C513710050025
2" x 5/4"	35	331	2	36	C513510050032	C513710050032
2" x 6/4"	35	298	2	36	C513510050040	C513710050040

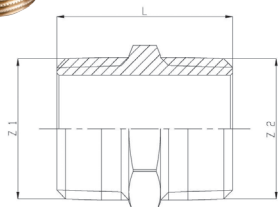
**Vsuvka**

rozměr Z1 x Z2	L (mm)	hmotnost (g)	balení (ks)		katalogové číslo	
			sáček	krabice	CW617N	CW602N
1/2" x 1/2"	36	43	20	220	C561010000015	C562110000015
3/4" x 3/4"	38	66	20	200	C561010000020	C562110000020
1" x 1"	41	113	10	100	C561010000025	C562110000025
5/4" x 5/4"	52	204	5	45	C561010000032	C562110000032
6/4" x 6/4"	52	264	5	30	C561010000040	C562110000040
2" x 2"	65	449	2	24	C561010000050	C562110000050

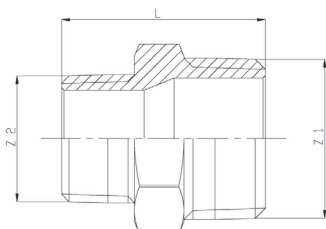
**Vsuvka redukovaná**

rozměr Z1 x Z2	L (mm)	hmotnost (g)	balení (ks)		katalogové číslo	
			sáček	krabice	CW617N	CW602N
3/4" x 1/2"	39	69	20	160	C563010020015	C563210020015
1" x 1/2"	41	113	10	100	C563010025015	C563210025015
1" x 3/4"	42	114	10	100	C563010025020	C563210025020
5/4" x 1/2"	45	177	5	45	C563010032015	C563210032015
5/4" x 3/4"	46	177	5	45	C563010032020	C563210032020
5/4" x 1"	50	194	5	45	C563010032025	C563210032025
6/4" x 1/2"	45	230	5	30	C563010040015	C563210040015
6/4" x 3/4"	46	229	5	30	C563010040020	C563210040020
6/4" x 1"	50	246	5	30	C563010040025	C563210040025
6/4" x 5/4"	51	247	5	30	C563010040032	C563210040032
2" x 3/4"	50	338	2	24	C563010050020	C563210050020
2" x 1"	54	362	2	24	C563010050025	C563210050025
2" x 5/4"	56	371	2	24	C563010050032	C563210050032
2" x 6/4"	56	380	2	24	C563010050040	C563210050040

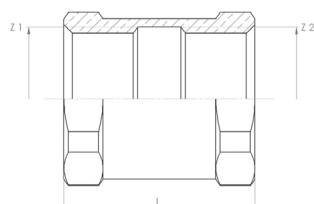

**Nátrubek**

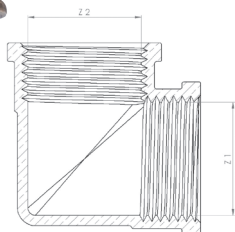
rozměr Z1 x Z2	L (mm)	hmotnost (g)	balení (ks)		katalogové číslo
			sáček	krabice	CW617N
1/2" x 1/2"	38	50	20	200	C511010000015
3/4" x 3/4"	40	75	15	150	C511010000020
1" x 1"	44	129	10	100	C511010000025
5/4" x 5/4"	50	187	5	45	C511010000032
6/4" x 6/4"	50	209	5	30	C511010000040
2" x 2"	58	365	2	20	C511010000050

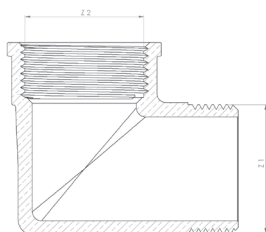

### Koleno s vnitřními závitů

rozměr Z1 x Z2	hmotnost (g)	balení (ks)		katalogové číslo	
		sáček	krabice	CW617N	CW602N
1/2" x 1/2"	58	10	150	C52121000015	C521510000015
3/4" x 3/4"	99	10	100	C52121000020	C521510000020
1" x 1"	154	10	60	C52121000025	C521510000025
5/4" x 5/4"	320	5	25		C521510000032
6/4" x 6/4"	378	4	16		C521510000040
2" x 2"	725	2	12		C521510000050



### Koleno

rozměr Z1 x Z2	hmotnost (g)	balení (ks)		katalogové číslo	
		sáček	krabice	CW617N	CW602N
1/2" x 1/2"	63	10	150	C52131000015	C521610000015
3/4" x 3/4"	100	10	80	C52131000020	C521610000020
1" x 1"	195	10	50	C52131000025	C521610000025
5/4" x 5/4"	360	5	25		C521610000032
6/4" x 6/4"	460	5	20		C521610000040
2" x 2"	795	2	12		C521610000050

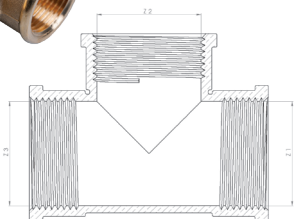

### T-kus

rozměr Z1 x Z2 x Z3	hmotnost (g)	balení (ks)		katalogové číslo	
		sáček	krabice	CW617N	CW602N
1/2" x 1/2" x 1/2"	79	10	120	C53221000015	C532510000015
3/4" x 3/4" x 3/4"	119	10	70	C53221000020	C532510000020
1" x 1" x 1"	186	10	40	C53221000025	C532510000025
5/4" x 5/4" x 5/4"	397	4	20		C532510000032
6/4" x 6/4" x 6/4"	460	4	16		C532510000040
2" x 2" x 2"	648	1	12		C532510000050

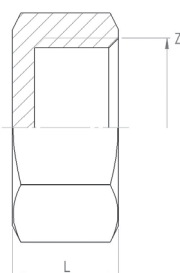

### Zátka s vnitřním závitem

rozměr Z1	L (mm)	hmotnost (g)	balení (ks)		katalogové číslo
			sáček	krabice	CW617N
1/2"	15	31	20	400	C551210000015
3/4"	16	50	20	300	C551210000020
1"	18	90	10	220	C551210000025
5/4"	21	145	5	80	C551210000032
6/4"	21	193	5	60	C551210000040
2"	26	260	2	36	C551210000050

### Zátka s vnějším závitem

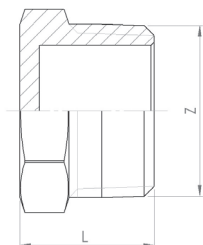

rozměr Z1	L (mm)	hmotnost (g)	balení (ks)		katalogové číslo CW617N
			sáček	krabice	
1/2"	18	28	20	400	C551010000015
3/4"	20	47	20	400	C551010000020
1"	22	81	10	220	C551010000025
5/4"	26	136	5	80	C551010000032
6/4"	26	177	5	60	C551010000040
2"	31	279	2	36	C551010000050

### Šroubení vodoměrné

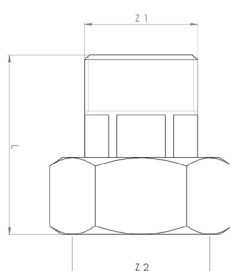

rozměr Z1 x Z2	L (mm)	hmotnost (g)	balení (ks)		katalogové číslo CW617N
			sáček	krabice	
1/2" x 3/4"	22	78	20	160	C571210015020
3/4" x 1"	24	117	10	100	C571210020025
1" x 5/4"	27	218	5	45	C571210025032
5/4" x 6/4"	30	327	2	24	C571210032040
6/4" x 2"	31	487	2	24	C571210040050

Dodávané včetně těsnění TEMAFAST ECONOMY

### Šroubení vodoměrné – dlouhé

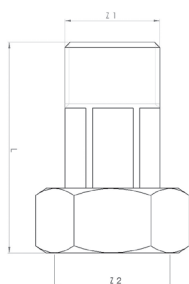

rozměr Z1 x Z2	L (mm)	hmotnost (g)	balení (ks)		katalogové číslo CW617N
			sáček	krabice	
1/2" x 3/4"	34	92	20	160	C571310015020
3/4" x 1"	40	144	10	100	C571310020025
1" x 5/4"	38	248	5	45	C571310025032
5/4" x 6/4"	40	365	2	24	C571310032040
6/4" x 2"	50	575	2	24	C571310040050

Dodávané včetně těsnění TEMAFAST ECONOMY